



ETHRATECH

INNOVATION AS ENERGY



AN ENEX TECHNOLOGIES COMPANY

PRODUCT CATALOGUE

Technology and Sustainability

Index

About	2
Our numbers	4
Our segments	6
Telecommunications	10
Outdoor packaged unit ED series	12
Outdoor packaged low power RR series / RF series	14
Indoor packaged unit ID series	16
Indoor packaged unit SP series	18
Indoor packaged low power RR series / RF series	20
Split system - Ceiling series	22
Split system - Under series	24
Split system wall mounted Series	26
Industrial environment	28
Series Industrial packaged ACUS	30
Series Industrial packaged CUS	32
Series Split system AI	34
Electrical Boards	36
Indoor air conditioning units CU ALX series	38
Free cooling system	40
Free cooling systems FC-GR series	42
Free cooling systems VFC series	43
Free cooling systems FCCB series	44
Free cooling systems FCCBE series	45
Free cooling systems CAM-I-ES series	46
Free cooling systems CAM-E-ES series	47
Free cooling systems PASCI series	48
Free cooling systems PASCE series	49
Free cooling systems CAM-I-IM series	50
Free cooling systems CAM-E-IM series	51

About

Enex Technologies is a transformative world leader in natural and energy efficient cooling, heating, ventilation and refrigeration equipment that began in the 1930s by producing ammonia natural refrigeration equipment, later adding CO₂, water and propane as natural refrigerants with low global warming potential.

1934
SAMIFI
FRANCE
INNOVATION AS ENERGY

1968
kobol
HEAT EXCHANGERS NATURALLY

1948
MORGANA
HEAT EXCHANGERS NATURALLY

1983
ROENEST
HEAT EXCHANGERS NATURALLY

1984
EMICON
INNOVATION AS ENERGY

1997
Arctic
INNOVATION AS ENERGY

1993
Hidros
INNOVATION AS ENERGY

1999
ETHRATECH
INNOVATION AS ENERGY

Pioneers and innovators in natural HVACR since the 1930s

2004
enex
INNOVATION AS ENERGY

2022

 **enex**
technologies

2012
eos
INNOVATION AS ENERGY

Our numbers

200M€
Revenues

1000+
Employees

12
Factories

125
Countries

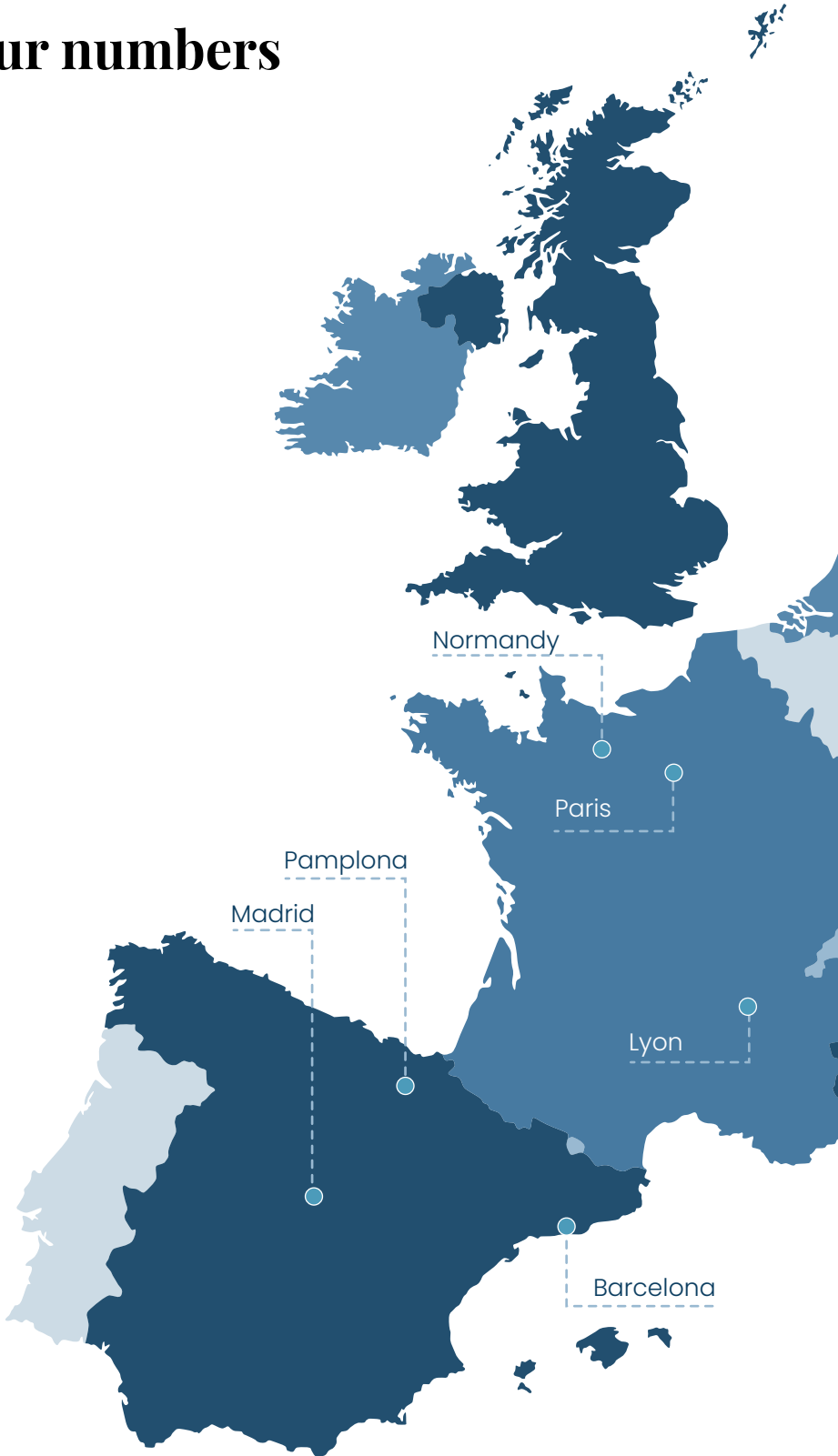

★ Headquarter

● Manufacturing, R&D site and commercial office

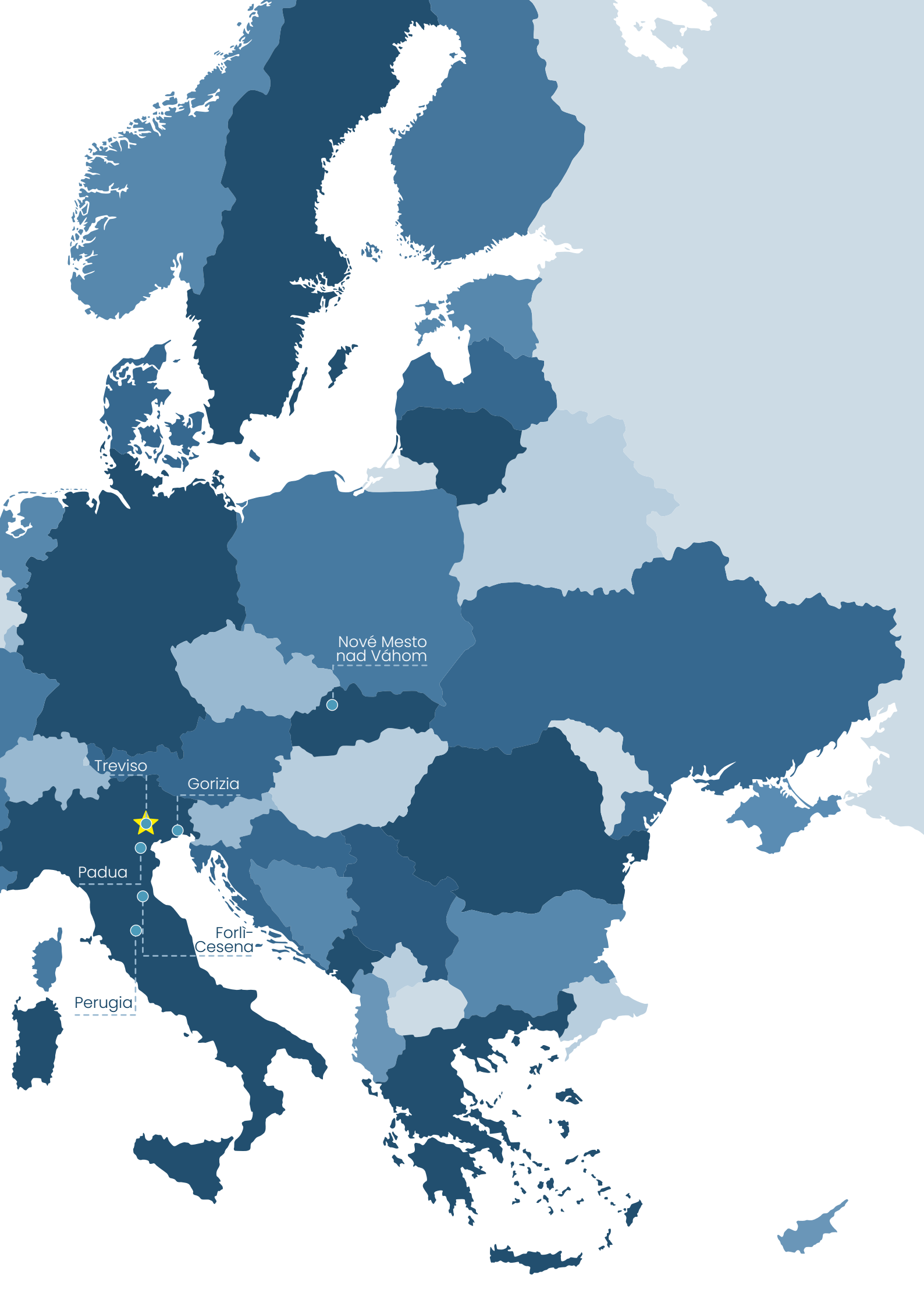

Nové Mesto nad Váhom

Treviso

Gorizia

Padua

Forlì-Cesena

Perugia

Our segments

Our leading natural refrigerant, energy efficiency and energy transition technologies transform the HVACR industry.



COOLING

Our chillers are designed to operate efficiently with all refrigerants, generating cold water for climatization or industrial processes.



REFRIGERATION

Our commercial and industrial refrigeration systems are designed for high performance, quality, reliability and carbon footprint reduction through the use of natural refrigerants Ammonia and CO₂.



HEATING

Our high efficiency heat pump range using natural refrigerant CO₂ is a simple-to use, elegant solution for applications requiring high quantities of sanitary hot water.

We are driven by strong values to create a better and more sustainable world



SUSTAINABILITY

Buildings consume 40% of the energy used in the developed world. HVACR systems use 60% of the energy in buildings. Our high efficiency solutions are central to reducing global warming, and we strive every day to help our customers reduce their carbon footprint by using natural refrigerants.



INNOVATION

Always leading. From pioneering the efficient and safe use of natural refrigerants to helping the industry move away from gas heat towards systems that use electricity.



COMMUNITIES

We are a European industrial champion, building clean factories that support new jobs, growth and expansion to new markets.



DIVERSITY & INCLUSION

At Enex Technologies we ensure that every colleague feels respected, valued and motivated to support our customers, every day.

References

EthraTech has a consolidated experience with the main Telecommunications Operators in Italy and Abroad, obtaining the homologation of its own solutions by Customers like TELECOM ITALIA, WIND TRE, VODAFONE, RFI, RAIWAY, ADIF and others. Tens of thousands of solutions with our air conditioners testify to EthraTech leadership in this sector. EthraTech works both in Italy and abroad as a strategic partner of the main Technology Providers, like ERICSSON NETWORKS, NOKIA SOLUTION, HUAWEI, ZTE.

Working in the air conditioning sector, EthraTech has also developed products for other markets.

EthraTech produces appliances of low refrigerant power, for the refrigeration of cabinets and power panels. Many companies, that work in the industrial sector, in particular siderurgy, have chosen to install our line of products inside foundries or other exacting environments in which very high temperatures and the problem of dust particles are found. Thanks to collaboration with the MILITARY sector, EthraTech has supplied air conditioners for military applications, for the cooling of shelters and technological rooms. The company is able to provide pre- and post-sale services also abroad, through qualified partners.



Technologies

INVERTER technology

Air conditioners with inverter technology allow substantial energy savings with advantages also in terms of thermal and acoustic comfort; specifically, temperature regulation is achieved by adjusting the speed of rotation of the compressor.

EthraTech ASC, PB13 and QPS electronics

EthraTech solutions are highly customisable thanks to the use of PLC controllers that equip the systems and are characterised by a multiplicity of inputs and outputs that guarantee a high level of flexibility. Specifically, the ASC system installed on board the air conditioners to manage their operations, also controls free-cooling and free-cooling systems simultaneously, guaranteeing the operation of the entire air-conditioning of technological rooms and the like, ensuring high levels of reliability.

PB13 controller supervises and controls free-cooling air exchange systems in independent mode, ensuring efficient air exchange based on the temperature conditions inside and outside the room to be cooled.

QPS implements site PLC functionality capable of optimised integration via Modbus protocol and/or digital commands of up to two air conditioners (even of different makes) and a free-cooling system. Concerning integration with customer monitoring systems, the QPS makes operating states and alarms available via digital contacts, Modbus protocol and SNMP.

Free-cooling system

This solution is designed to allow ENERGY SAVING even on sites where air conditioners without a free-cooling system have been previously installed. This solution, realised by means of one or more fans, is managed by means of an EthraTech PLC and allows the implementation of efficient cooling and air exchange systems in both supply and extract modes.



Telecommunications

In telecommunications, temperature management within shelters, rooms and technology rooms is a key element in ensuring the proper functioning of electronic equipment. These systems include indoor and outdoor packaged air conditioners, split systems and underfloor units, each with different characteristics and capacities to meet the cooling needs of different environments.



Data centre



Motorway



Railway



Telecom



**Optimal thermal control
solutions and reliable
telecommunications
all the time.**



OUTDOOR PACKAGED UNIT

Outdoor packaged air conditioning units air cooled type ED Series

Cooling capacity from 6,3 kw to 17,2 kw
Operation limits from -20°C to +45°C
On-off / inverter
Electronic temperature control



Outdoor packaged air conditioning units air cooled type, ideals for installations inside room, shelter for radio base station and data processing centre. The cooling air is exhausted from above and sent downwards.

MAIN FEATURES

- Mainframe and panels made of galvanized steel
- Aluminum-aluminum microchannel condenser battery
- Fans evaporating section type EC, 48Vdc
- The fans of the condensation section have a variable speed in accordance with the condensation pressure
- On request: Ethernet board, Serial RS232/485, SNMP&Web

COOLING MODE MOD. ER

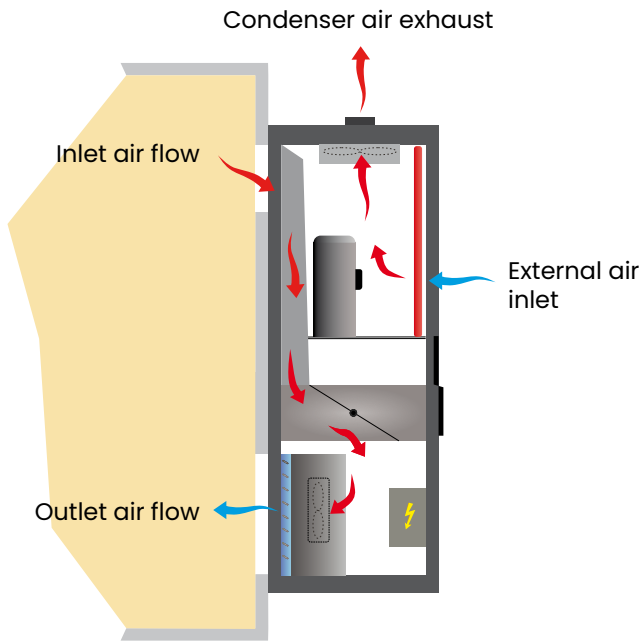

FREE COOLING MODE MOD. EF

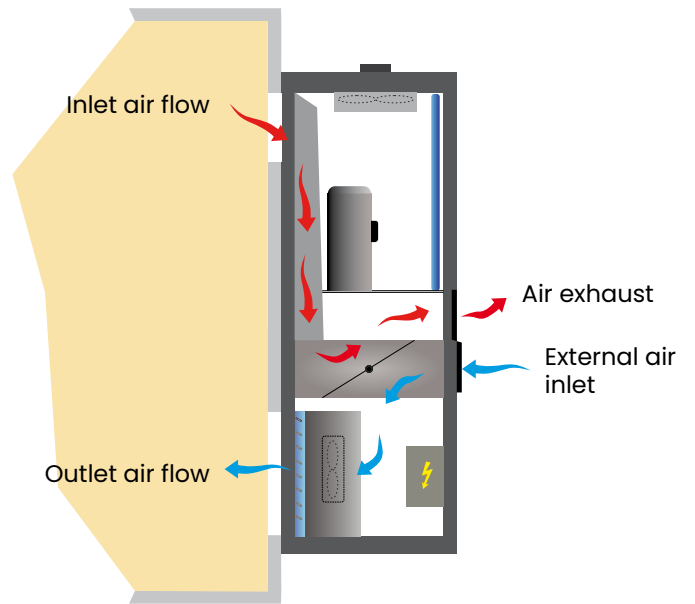

TECHNICAL DATA ON/OFF AND INVERTER VERSIONS

Model		AE50ER1DP	AE80ER1DP	AE80ER3DP	AE100ER3DP	AE140ER3DP	AE170ER3DP
		AE50EF1DP	AE80EF1DP	AE80EF3DP	AE100EF3DP	AE140EF3DP	AE170EF3DP
Compressor		Hermetic	Hermetic	Hermetic	Hermetic	Hermetic	Hermetic
Total cooling capacity ⁽¹⁾	W	6300	8100	8100	10200	14100	17200
Sensitive cooling capacity	W	6300	8100	8100	10200	14100	17200
Heating capacity (optional)	W	1500	3000	3000	3000	3000	3000
Voltage supply	V/pH/Hz	230/1/50	230/1/50	400/3+N/50	400/3+N/50	400/3+N/50	400/3+N/50

Modello		AE2/8ER1DP	AE2/8ER3DP	AE3/10ER3DP	AE5/14ER3DP	AE6/17ER3DP
		AE2/8EF1DP	AE2/8EF3DP	AE3/10EF3DP	AE5/14EF3DP	AE6/17EF3DP
Compressor		Hermetic Inverter	Hermetic Inverter	Hermetic Inverter	Hermetic Inverter	Hermetic Inverter
Total cooling capacity ⁽¹⁾	W	2000/7700	2000/7700	3000/10200	5000/14100	6000/17200
Sensitive cooling capacity	W	2000/7700	2000/7700	3000/10200	5000/14100	6000/17200
Heating capacity (optional)	W	1500	1500	3000	3000	3000
Voltage supply	V/pH/Hz	230/1/50	230/1/50	400/3+N/50	400/3+N/50	400/3+N/50

(1) External Temperature 35°C - Inside Temperature 30°C - R.H. =20%

OUTDOOR PACKAGED LOW POWER SERIES

Outdoor packaged air conditioning units air cooled type
RR Series / RF Series

Cooling capacity from 1,7 kW to 4,3 kW
Operation limits from -20°C to +45°C
On-off / inverter
Electronic temperature control



RR Series



RF Series

Packaged air conditioning units air cooled type, suitable for installations in room, shelter for radio base station and data processing centre. The cooling air is exhausted from above and sent downwards.

MAIN FEATURES

- Mainframe and panels made of galvanized steel
- Fans evaporating section type AC, 230Vac
- Condensing section fans type EC, 230Vac
- Free Cooling section fans type AC, 230Vac or EC, 48Vdc (Mod.RF only)
- On request: Ethernet board, Serial RS232/485, SNMP&Web

COOLING MODE MOD. RR

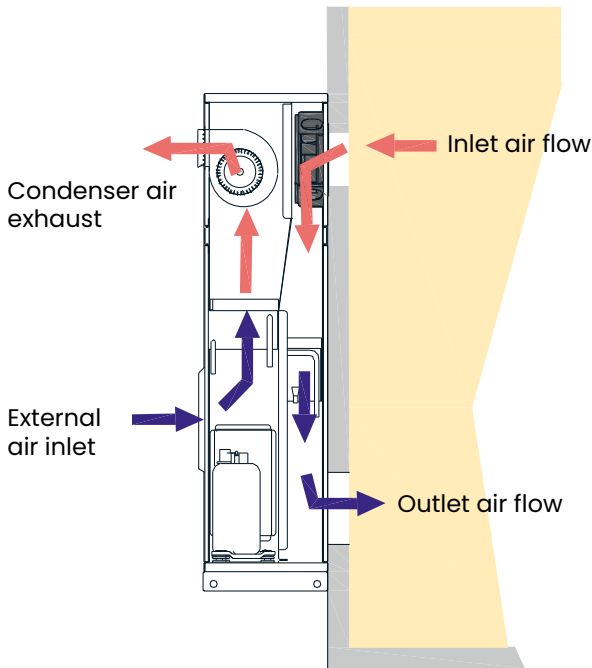

FREE COOLING MODE MOD. RF

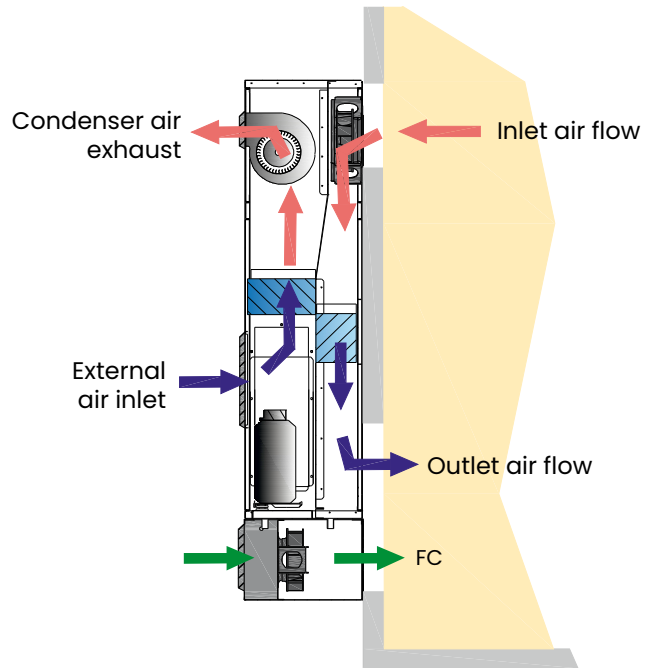

TECHNICAL DATA

Model		AE15RR1-E AE15RF1-E	AE25RR1-E AE25RF1-E	AE35RR1-E AE35RF1-E	AE45RR1-E AE45RF1-E
Compressor		Hermetic	Hermetic	Hermetic	Hermetic
Total cooling capacity ⁽¹⁾	W	1700	2300	3500	4300
Sensitive cooling capacity	W	1700	2300	3500	4300
Heating capacity (optional)	W	1500	1500	1500	1500
Voltage supply	V/pH/Hz	230/1/50	230/1/50	230/1/50	230/1/50

(1) External Temperature 35°C - Inside Temperature 30°C - R.H. =20%

INDOOR PACKAGED UNIT

Indoor packaged air conditioning units air cooled type ID Series

Cooling capacity from 6,3 kW to 17,2 kW
Operation limits from -20°C to +45°C
On-off / inverter
Electronic temperature control



Outdoor packaged air conditioning units air cooled type, ideals for installations inside room, shelter for radio base station and data processing centre. The cooling air is exhausted from above and sent downwards.

MAIN FEATURES

- Mainframe and panels made of galvanized steel
- Aluminum-aluminum microchannel condenser battery
- Fans evaporating section type EC, 48Vdc
- Variable condensing section fan speed as a function of condensing pressure
- On request: Ethernet board, Serial RS232/485, SNMP&Web

COOLING MODE MOD. IR

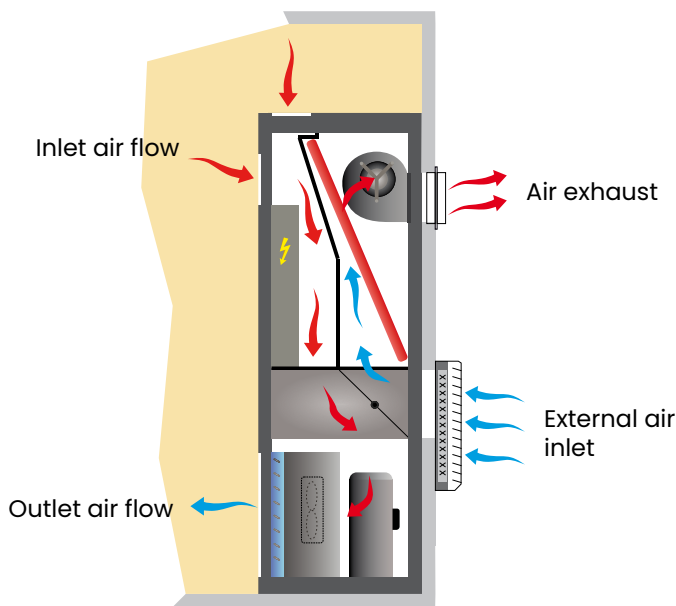

FREE COOLING MODE MOD. IF

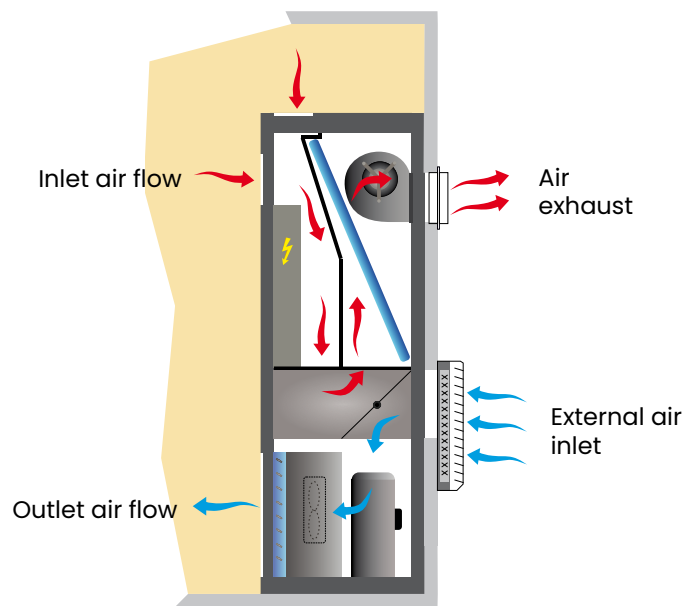

TECHNICAL DATA ON/OFF AND INVERTER VERSIONS

Model		AE50IR1DP	AE80IR1DP	AE80IR3DP	AE100IR3DP	AE140IR3DP	AE170IR3DP
		AE50IF1DP	AE80IF1DP	AE80IF3DP	AE100IF3DP	AE140IF3DP	AE170IF3DP
Compressor		Hermetic	Hermetic	Hermetic	Hermetic	Hermetic	Hermetic
Total cooling capacity ⁽¹⁾	W	6300	8100	8100	10200	14100	17200
Sensitive cooling capacity	W	6300	8100	8100	10200	14100	17200
Heating capacity (optional)	W	1500	3000	3000	3000	3000	3000
Voltage supply	V/pH/Hz	230/1/50	230/1/50	400/3+N/50	400/3+N/50	400/3+N/50	400/3+N/50

Modello		AE2/8ER1DP	AE2/8ER3DP	AE3/10ER3DP	AE5/14ER3DP	AE6/17ER3DP
		AE2/8EF1DP	AE2/8EF3DP	AE3/10EF3DP	AE5/14EF3DP	AE6/17EF3DP
Compressor		Hermetic Inverter	Hermetic Inverter	Hermetic Inverter	Hermetic Inverter	Hermetic Inverter
Total cooling capacity ⁽¹⁾	W	2000/7600	2000/7600	3000/10000	5000/13900	6000/17000
Sensitive cooling capacity	W	2000/7600	2000/7600	3000/10000	5000/13900	6000/17000
Heating capacity (optional)	W	1500	1500	3000	3000	3000
Voltage supply	V/pH/Hz	230/1/50	400/3+N/50	400/3+N/50	400/3+N/50	400/3+N/50

(1) External Temperature 35°C - Inside Temperature 30°C - R.H. =20%

INDOOR PACKAGED UNIT

Air-cooled Underfloor Packaged Indoor Air Conditioners SP Series

Cooling capacity from 6,1 kW to 17 kW
Operation limits from -20°C to +45°C
On-off / inverter
Electronic temperature control



Air-cooled **underfloor** monobloc indoor air conditioners, ideal for room installations, radio base station shelters and technological rooms in general. The cooling air is taken from above and conveyed into the under-floor.

MAIN FEATURES

- Mainframe and panels made of galvanized steel
- Aluminum-aluminum microchannel condenser battery
- Fans evaporating section type EC, 48Vdc
- Variable condensing section fan speed as a function of condensing pressure
- On request: Ethernet board, Serial RS232/485, SNMP&Web

COOLING MODE MOD. IR

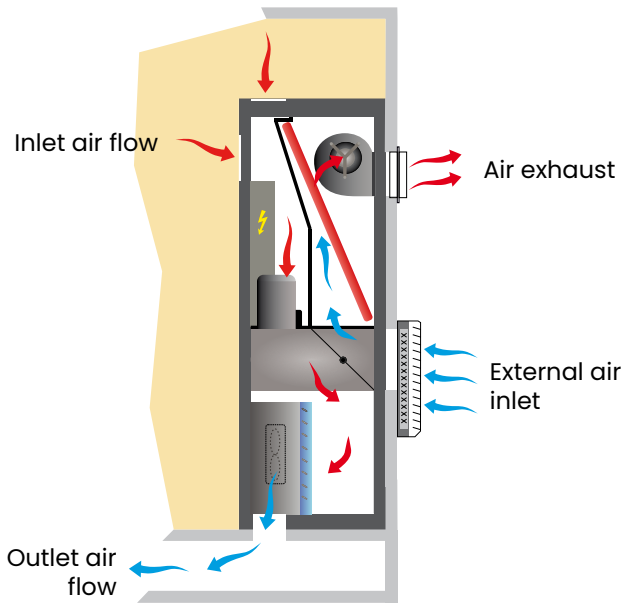

FREE COOLING MODE MOD. IF

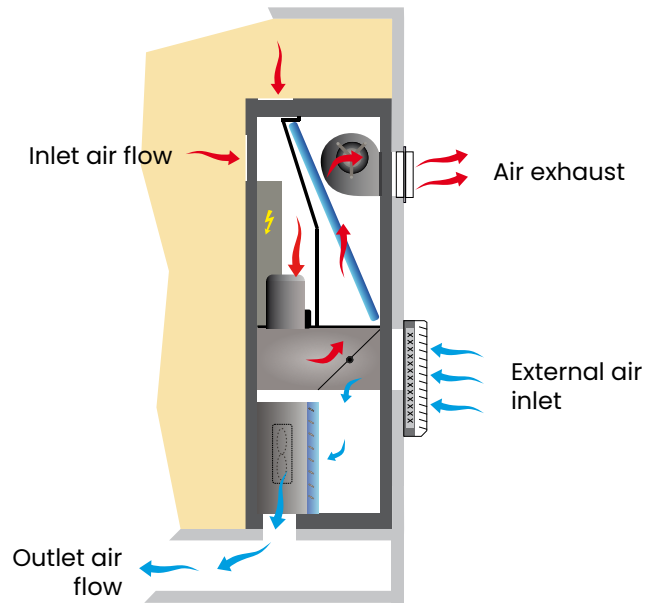

TECHNICAL DATA ON/OFF AND INVERTER VERSIONS

Model		AE50IR1SP AE50IF1SP	AE80IR1SP AE80IF1SP	AE80IR3SP AE80IF3SP	AE100IR3SP AE100IF3SP	AE140IR3SP AE140IF3SP	AE170IR3SP AE170IF3SP
Compressor		Hermetic	Hermetic	Hermetic	Hermetic	Hermetic	Hermetic
Total cooling capacity ⁽¹⁾	W	6100	7900	7900	10000	13900	17000
Sensitive cooling capacity	W	6100	7900	7900	10000	13900	17000
Heating capacity (optional)	W	1500	3000	3000	3000	3000	3000
Voltage supply	V/pH/Hz	230/1/50	230/1/50	400/3+N/50	400/3+N/50	400/3+N/50	400/3+N/50

Modello		AE2/8ER1DP AE2/8EF1DP	AE2/8ER3DP AE2/8EF3DP	AE3/10ER3DP AE3/10EF3DP	AE5/14ER3DP AE5/14EF3DP	AE6/17ER3DP AE6/17EF3DP
Compressor		Hermetic Inverter	Hermetic Inverter	Hermetic Inverter	Hermetic Inverter	Hermetic Inverter
Total cooling capacity ⁽¹⁾	W	2000/7600	2000/7600	3000/10000	5000/13900	6000/17000
Sensitive cooling capacity	W	2000/7600	2000/7600	3000/10000	5000/13900	6000/17000
Heating capacity (optional)	W	1500	1500	3000	3000	3000
Voltage supply	V/pH/Hz	230/1/50	400/3+N/50	400/3+N/50	400/3+N/50	400/3+N/50

(1) External Temperature 35°C - Inside Temperature 30°C - R.H. =20%

INDOOR PACKAGED LOW POWER SERIES

Indoor packaged air conditioning units air cooled type
RR Series / RF Series

Cooling capacity from 1,7 kW to 4,3 kW
Operation limits from -20°C to +45°C
Electronic temperature control



RR Series

RF Series

Packaged air conditioning units air cooled type, suitable for installations in room, shelter for radio base station and data processing centre. The cooling air is exhausted from above and sent downwards.

MAIN FEATURES

- Mainframe and panels made of galvanized steel
- Fans evaporating section type AC, 230Vac
- Condensing section fans type EC, 230Vac
- Free Cooling section fans type AC, 230Vac or EC, 48Vdc (Mod.RF only)
- On request: Ethernet board, Serial RS232/485, SNMP&Web

COOLING MODE MOD. RR

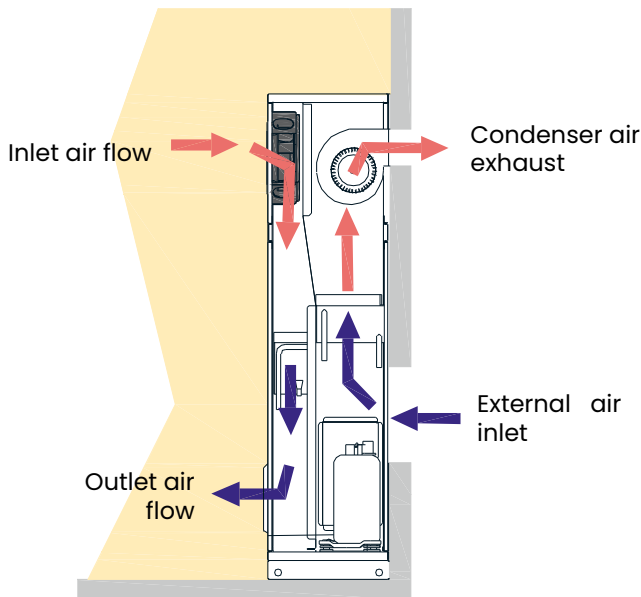

FREE COOLING MODE MOD. RF

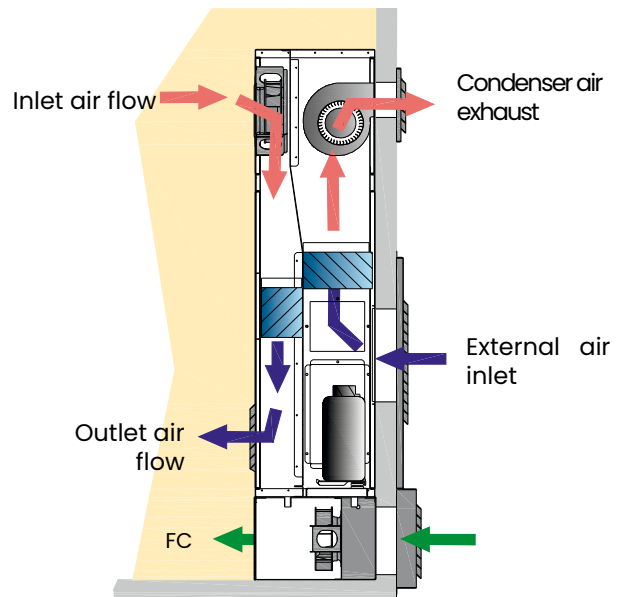

TECHNICAL DATA

Model		AE15RR1-I AE15RF1-I	AE25RR1-I AE25RF1-I	AE35RR1-I AE35RF1-I	AE45RR1-I AE45RF1-I
Compressor		Hermetic	Hermetic	Hermetic	Hermetic
Total cooling capacity ⁽¹⁾	W	1700	2300	3500	4300
Sensitive cooling capacity	W	1700	2300	3500	4300
Heating capacity (optional)	W	1500	1500	1500	1500
Voltage supply	V/pH/Hz	230/1/50	230/1/50	230/1/50	230/1/50

(1) External Temperature 35°C - Inside Temperature 30°C - R.H. =20%

SPLIT SYSTEM

Split system air-conditioners air condensed Ceiling Series

Cooling capacity from 6,3 kW to 14,2 kW
Operation limits from -20°C to +45°C
On-off / inverter
Electronic temperature control

OTHER VERSIONS

Three-piece (indoor unit, outdoor unit, compressor unit)



Indoor unit



Outdoor unit

Split air conditioning units air cooled type, suitable for installations inside room, shelter for radio base station and data processing centre. The indoor unit's air flow can be directed downwards (displacement) or horizontally (convection).

MAIN FEATURES

- Outdoor unit with press-folded steel frame and pre-painted or painted aluminium panels
- Internal unit with aluminum made mainframe and panels
- Aluminum-aluminum microchannel condenser battery
- Fans evaporating section type EC, 48Vdc
- On request: Ethernet board, Serial RS232/485, SNMP&Web

COOLING MODE MOD. SR

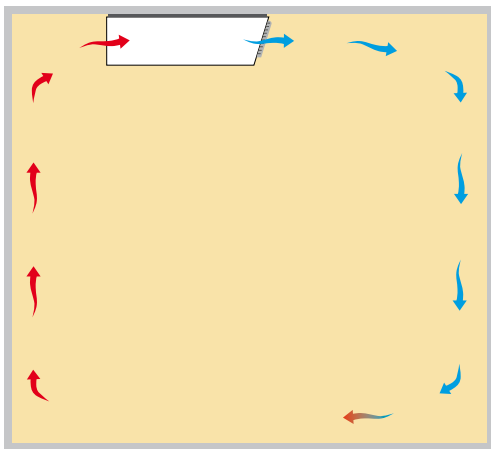

FREE COOLING MODE MOD. SF

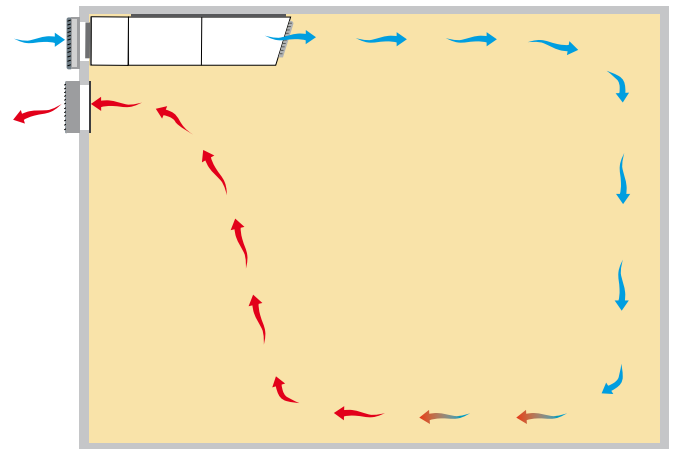

TECHNICAL DATA ON/OFF AND INVERTER VERSIONS

Model		AE50SR1DP AE50SF1DP	AE80SR1DP AE80SF1DP	AE80SR3DP AE80SF3DP	AE100SR3DP AE100SF3DP	AE140SR3DP AE140SF3DP
Compressor		Hermetic	Hermetic	Hermetic	Hermetic	Hermetic
Total cooling capacity ⁽¹⁾	W	6300	8600	8600	10200	14200
Sensitive cooling capacity	W	6300	8600	8600	10200	14200
Heating capacity (optional)	W	1500	3000	3000	3000	3000
Voltage supply	V/pH/Hz	230/1/50	230/1/50	400/3+N/50	400/3+N/50	400/3+N/50

Modello		AE2/8SF1DP AE2/8SR1DP	AE2/8SF3DP AE2/8SR3DP	AE2/10SF3DP AE2/10SR3DP	AE5/14SF3DP AE5/14SR3DP
Compressor		Hermetic Inverter	Hermetic Inverter	Hermetic Inverter	Hermetic Inverter
Total cooling capacity ⁽¹⁾	W	2000/8200	2000/8200	3000/10200	5000/14200
Sensitive cooling capacity	W	2000/8200	2000/8200	3000/10200	5000/14200
Heating capacity (optional)	W	1500	1500	3000	3000
Voltage supply	V/pH/Hz	230/1/50	400/3+N/50	400/3+N/50	400/3+N/50

(1) External Temperature 35°C - Inside Temperature 30°C - R.H. =20%

SPLIT SYSTEM

Split system air-conditioners air condensed Under Series

Cooling capacity from 2,0 kW to 17,2 kW
Operation limits from -20°C to +45°C
Inverter
Electronic temperature control

OTHER VERSIONS

Three-piece (indoor unit, outdoor unit, compressor unit)



Indoor unit



Outdoor unit

Split air conditioning units air cooled type, suitable for installations inside room, shelter for radio base station and data processing centre. The indoor unit's air flow can be directed downwards.

MAIN FEATURES

- Outdoor unit with press-folded steel frame and pre-painted or painted aluminium panels
- Internal unit with aluminum made mainframe and panels
- Aluminum-aluminum microchannel condenser battery
- Fans evaporating section type EC, 48Vdc
- On request: Ethernet board, Serial RS232/485, SNMP&Web

COOLING MODE MOD. SR

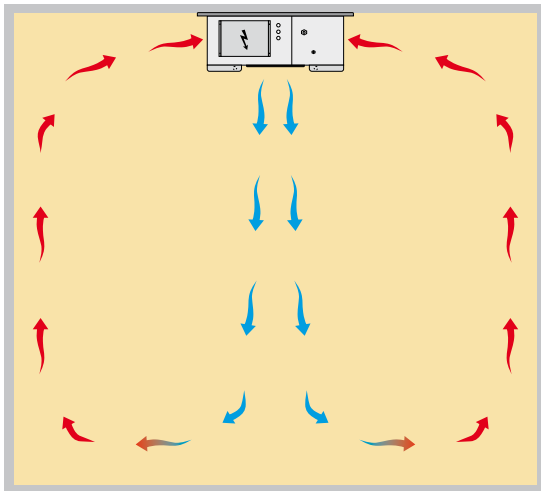

FREE COOLING MODE MOD. SF

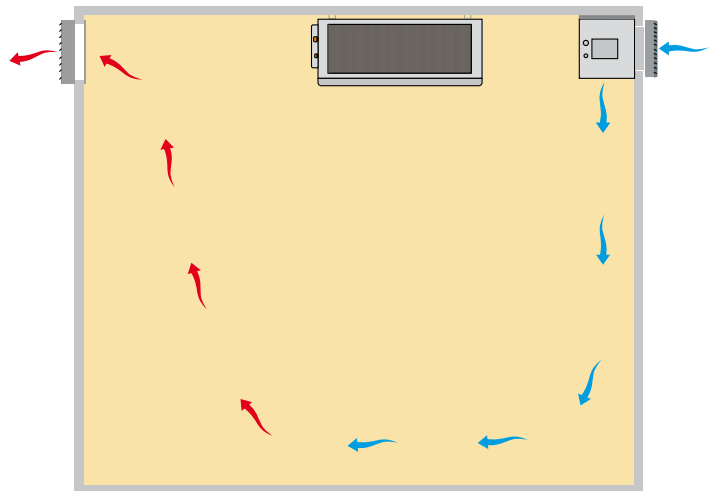

TECHNICAL DATA

Model		AE2/8SR1UP AE2/8SFIUP	AE2/8SR3UP AE2/8SF3UP	AE3/10SR3UP AE3/10SF3UP	AE5/14SR3UP AE5/14SF3UP	AE6/17SR3UP AE6/17SF3UP
Compressor		Inverter Hermetic	Inverter Hermetic	Inverter Hermetic	Inverter Hermetic	Inverter Hermetic
Total cooling capacity ⁽¹⁾	W	2000/8400	2000/8400	3000/10400	5000/14200	6000/17200
Sensitive cooling capacity	W	2000/8400	2000/8400	3000/10400	5000/14200	6000/17200
Heating capacity (optional)	W	1500	1500	3000	3000	3000
Voltage supply	V/pH/Hz	230/1/50	230/1/50	400/3+N/50	400/3+N/50	400/3+N/50

(1) External Temperature 35°C - Inside Temperature 30°C - R.H. =20%

SPLIT SYSTEM

Split system air-conditioners air condensed Wall mounted Series

Cooling capacity from 6,3 kW to 17,2 kW
Operation limits from -20°C to +45°C
On-off / inverter
Electronic temperature control

OTHER VERSIONS

Three-piece (indoor unit, outdoor unit, compressor unit)



Indoor unit



Outdoor unit

Split air conditioning units air cooled type, suitable for installations inside room, shelter for radio base station and data processing centre. The cooling air is exhausted from above and sent downwards.

MAIN FEATURES

- Outdoor unit with press-folded steel frame and pre-painted or painted aluminium panels
- Internal unit with aluminum made mainframe and panels
- Aluminum-aluminum microchannel condenser battery
- Fans evaporating section type EC, 48Vdc
- On request: Ethernet board, Serial RS232/485, SNMP&Web

COOLING MODE MOD. SR

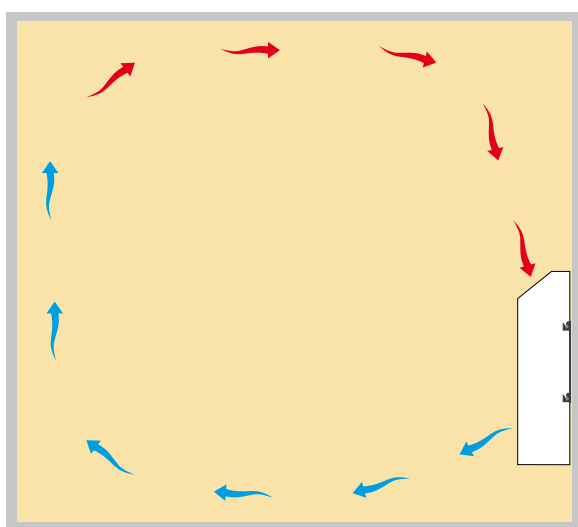

FREE COOLING MODE MOD. SF

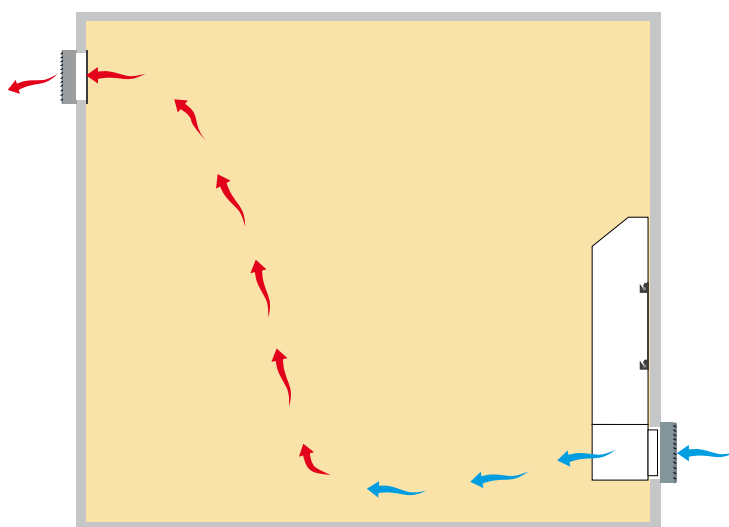

TECHNICAL DATA ON/OFF AND INVERTER VERSIONS

Model		AE50SR1DPV	AE80SR1DPV	AE80SR3DPV	AE100SR3DPV	AE140SR3DPV	AE170SR3DPV
		AE50SF1DPV	AE80SF1DPV	AE80SF3DPV	AE100SF3DPV	AE140SF3DPV	AE170SF3DPV
Compressor		Hermetic	Hermetic	Hermetic	Hermetic	Hermetic	Hermetic
Total cooling capacity ⁽¹⁾	W	6300	8600	8600	10200	14200	17200
Sensitive cooling capacity	W	6300	8600	8600	10200	14200	17200
Heating capacity (optional)	W	1500	3000	3000	3000	3000	3000
Voltage supply	V/pH/Hz	230/1/50	230/1/50	400/3+N/50	400/3+N/50	400/3+N/50	400/3+N/50

Modello		AE2/8SF1DPV	AE2/8SF3DPV	AE2/10SF3DPV	AE5/14SF3DPV	AE6/17SF3DPV
		AE2/8SR1DPV	AE2/8SR3DPV	AE2/10SR3DPV	AE5/14SR3DPV	AE6/17SR3DPV
Compressor		Hermetic Inverter	Hermetic Inverter	Hermetic Inverter	Hermetic Inverter	Hermetic Inverter
Total cooling capacity ⁽¹⁾	W	2000/8200	2000/8200	3000/10200	5000/14200	6000/17200
Sensitive cooling capacity	W	2000/8200	2000/8200	3000/10200	5000/14200	6000/17200
Heating capacity (optional)	W	1500	1500	3000	3000	3000
Voltage supply	V/pH/Hz	230/1/50	400/3+N/50	400/3+N/50	400/3+N/50	400/3+N/50

(1) External Temperature 35°C - Inside Temperature 30°C - R.H. =20%



Industrial environment

In the industrial environment, where dust, vibrations and extreme temperatures are a daily challenge, we offer air conditioning solutions specifically designed to operate in harsh environments. These systems provide precise electronic temperature control and are ideal for cooling containers, electrical cabinets, switchboards and other similar applications, with the possibility of ducting and treated coils for corrosive environments.



Siderurgy



Industry





**Monobloc galvanised
steel industrial air-
conditioners with precise
electronic control and
flexible design**

INDOOR PACKAGED

Packaged self-cooling air conditioners for containers or electrical cabins

ACUS Series

Cooling capacity 9,0 kW
Operation limits from -40°C to +85°C
Electronic temperature control

R1234
yf

R134A



Packaged self-cooling air conditioners for indoor use, specifically designed and manufactured to operate in extreme conditions in presence of dust and vibration and high temperature. Ideal for cooling containers and electrical cabins by ducting.

MAIN FEATURES

- Mainframe and panels made of galvanized steel
- High corrosion resistant
- Resistance to dust and vibrations
- On-board electrical box
- The condenser section fan is regulated by the pressure switch control
- Remote user interface panel
- Adjustable exhaust/treated air flow

MODE OF OPERATION

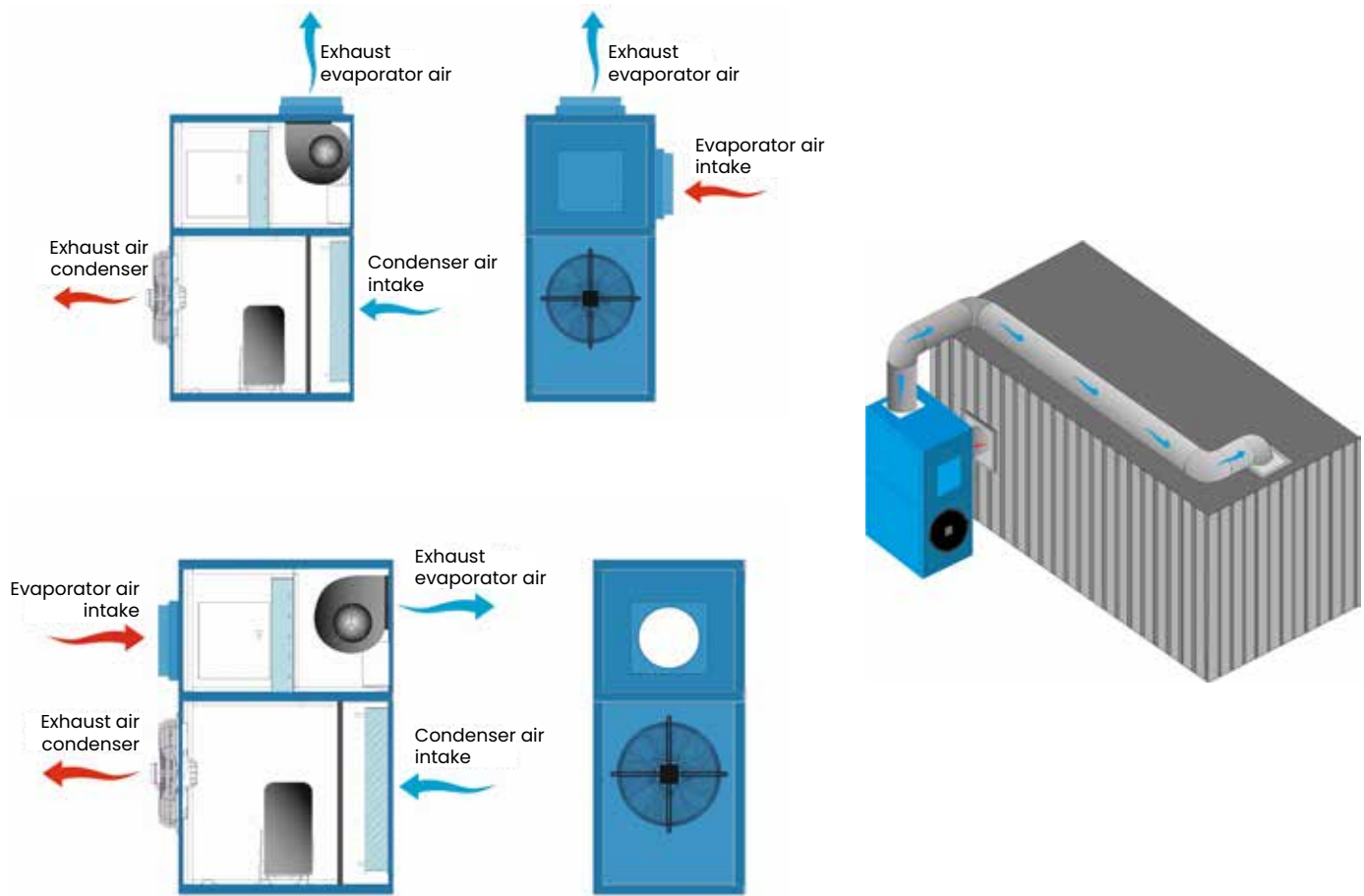

TECHNICAL DATA

Model		ACUS91	ACUS95
Compressor		Scroll	Scroll
Total cooling capacity ⁽¹⁾	W	9000	9000
Sensitive cooling capacity	W	8100	8100
Voltage supply	V/pH/Hz	400/3/50	480/3/60

(1) External Temperature 60°C - Inside Temperature 30°C - R.H. =50%

INDOOR PACKAGED

Packaged self-cooling air conditioners for containers or electrical cabins CUS Series

Cooling capacity from 2,7 kW to 4,5 kW
Operation limits from -40°C to +80°C
Electronic temperature control

R1234
yf

R134A



Packaged self-cooling air conditioners for indoor use, specifically designed to operate in industrial environments, in the presence of dust, vibrations and high temperatures. Ideal for cooling electrical boards, electrical substations and others.

MAIN FEATURES

- Mainframe and panels made of galvanized steel
- High corrosion resistant
- Resistance to dust and vibrations
- Electrical board with external interface user panel
- The condensing section fan is regulated by the pressure switch control
- Installation on outdoor walls, backpack positioning
- Possibility of ducting

MODE OF OPERATION

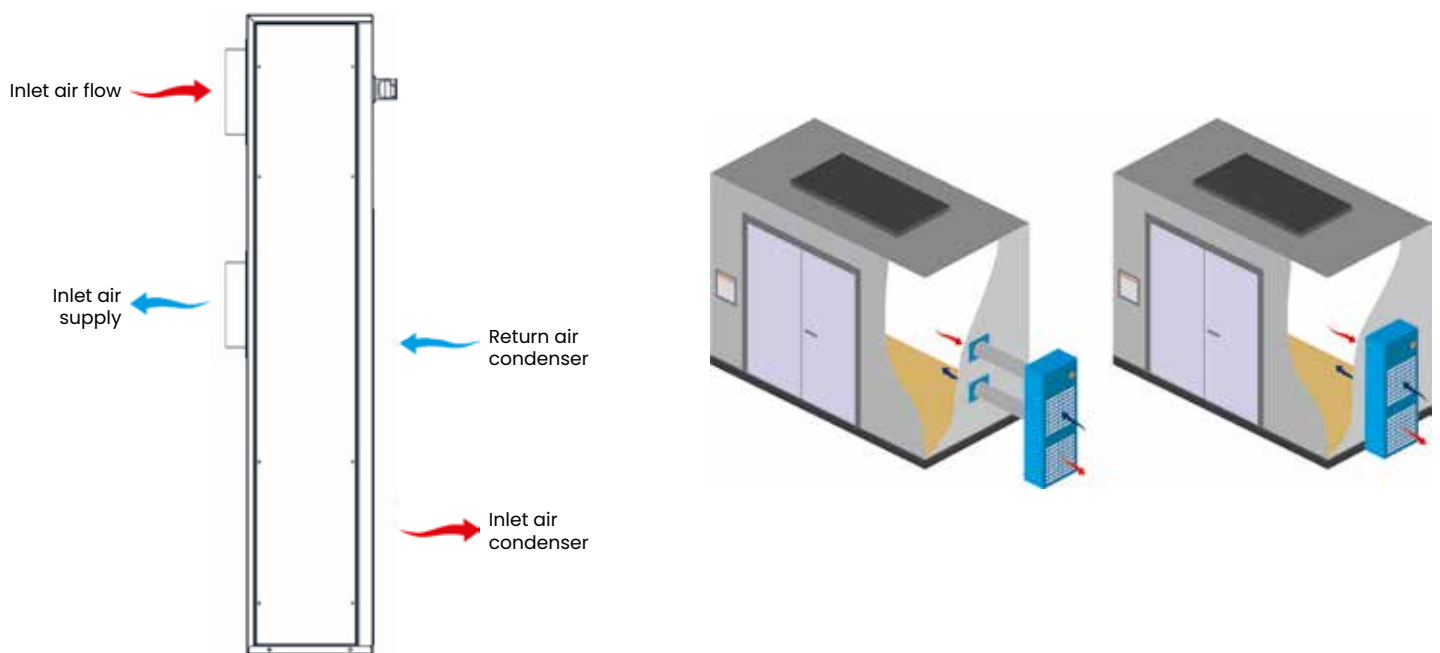

TECHNICAL DATA

Model		CUS183	CUS222	CUS301
Compressor		Scroll	Scroll	Scroll
Total cooling capacity ⁽¹⁾	W	1800	2500	2800
Sensitive cooling capacity	W	1700	2350	2600
Voltage supply	V/pH/Hz	230/1/50	460/3/60	400/3/50

(1) External Temperature 60°C - Inside Temperature 30°C - R.H. =50%

SPLIT SYSTEM

Split system air-conditioners air condensed AI Series

Cooling capacity from 6,2 kW to 8,7 kW
Operation limits from -20°C to +75°C
Electronic temperature control

OTHER VERSIONS

Indoor unit for ceiling or wall mounting



Wall-mounted indoor unit
mod. DCV



Ceiling mounted indoor unit
mod. DC



Outdoor unit

Split system air-conditioning units, air-cooled, specifically designed to operate in industrial, dusty and high temperature environments. Ideal for cooling electrical cabins and containers.

MAIN FEATURES

- Mainframe and panels made of galvanized steel
- High corrosion resistant
- Resistance to dust and vibrations
- Electrical board with external interface user panel
- The fan of the condensing section is regulated by the control pressure switch

CEILING-MOUNTED MODE

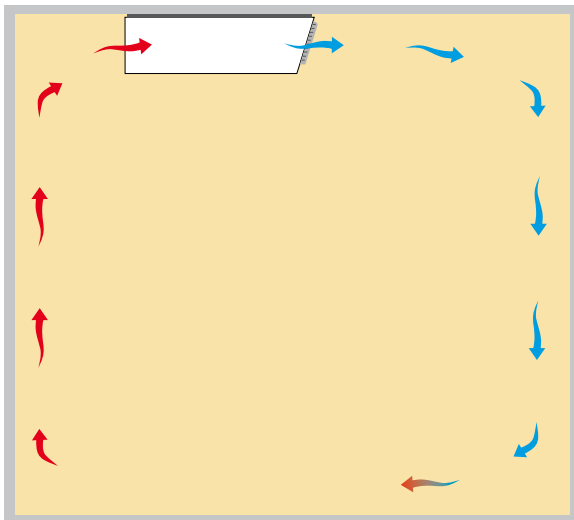

WALL-MOUNTED MODE

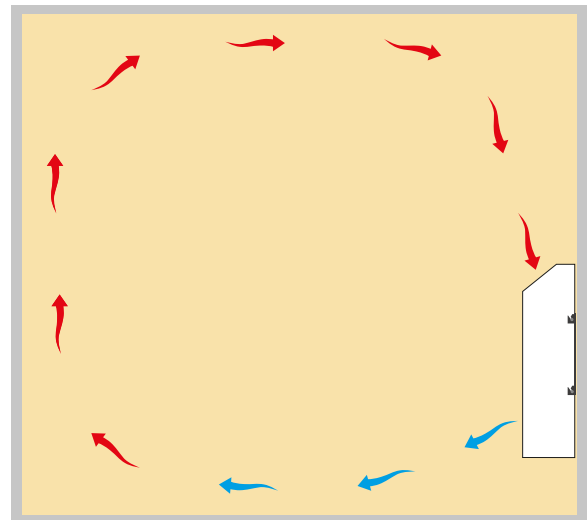

TECHNICAL DATA

Model	AI60SR3DC			AI60SR3DCV			AI80SR3DC		AI80SR3DCV			
	(1)	(2)	(3)	(1)	(2)	(3)	(1)	(3)	(1)	(3)		
Indoor unit	Ceiling			Wall			Wall		Wall			
Compressor	W			Semi-hermetic								
Total cooling capacity ⁽¹⁾	W	6200	5500	4700	6200	5500	4700	8700	5600	8700	5600	
Sensitive cooling capacity ⁽¹⁾	W	6000	5300	4700	6000	5300	4700	8300	5400	8300	5400	
Voltage supply	V/pH/Hz			400/3/50+N+T								

- (1) External Temperature 35°C - Inside Temperature 27°C - R.H.=50%
 (2) External Temperature 60°C - Inside Temperature 30°C - R.H.=50%
 (3) External Temperature 70°C - Inside Temperature 30°C - R.H.=50%



Electrical Boards

Air-conditioning units of the CU_ALX series are packaged indoor air-conditioning units, ideal for cooling electrical boards. Thanks to a painted sheet metal structure and an aluminium micro-channel condenser coil, these solutions guarantee high reliability and optimal performance even in challenging environments.



Cabinet

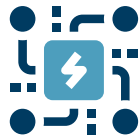

Electrical boards



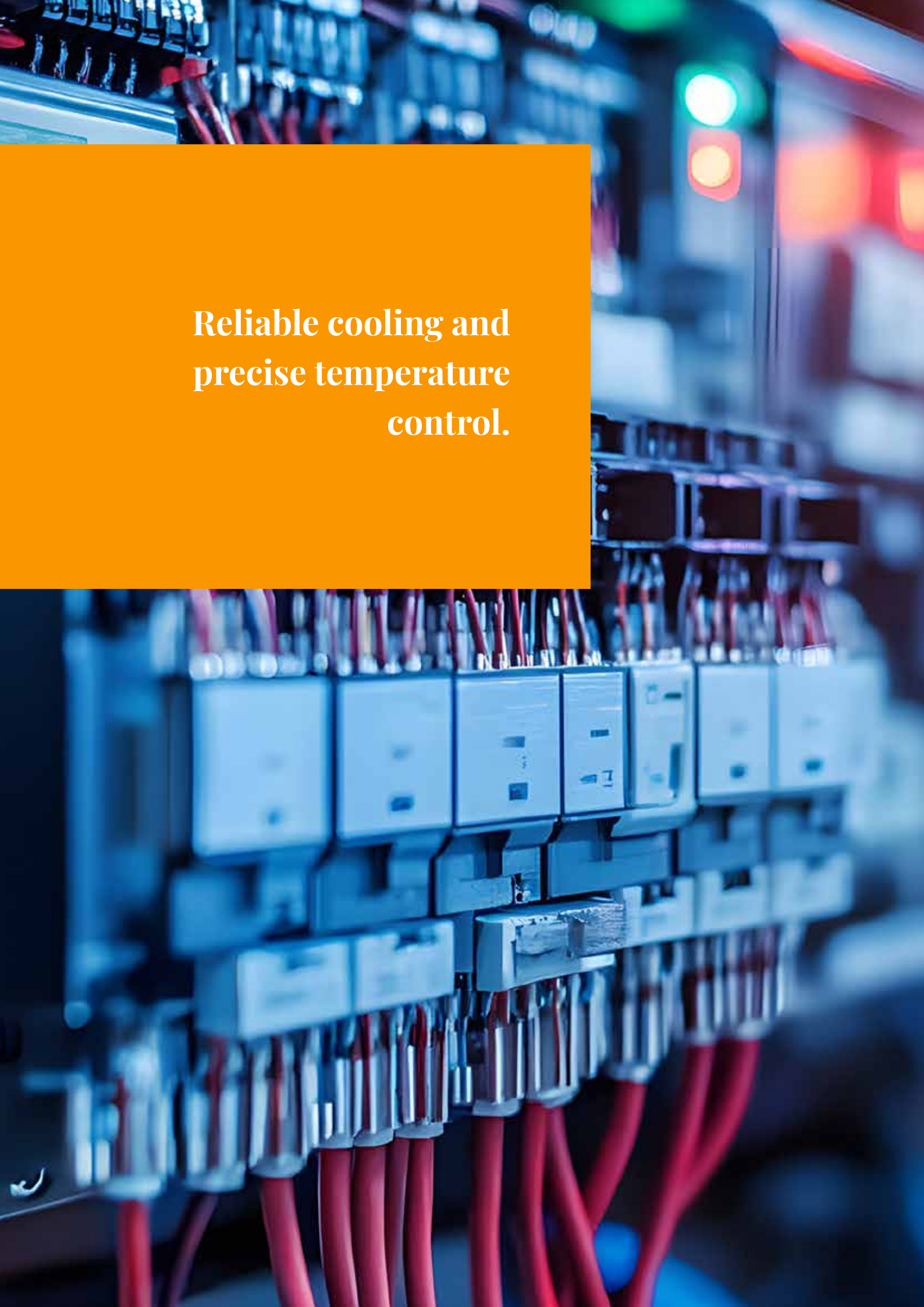

**Reliable cooling and
precise temperature
control.**

INDOOR AIR CONDITIONING UNITS

Indoor packaged air conditioners

CU-ALX Series

Cooling capacity from 0,6 kW to 2,5 kW

Operation limits from -20°C to +55°C

Electronic temperature control



The CU_ALX series air-conditioning units are monobloc indoor units, ideal for cooling electrical boards and similar, designed to be installed on external walls (backpack positioning).

MAIN FEATURES

- Mainframe and panels made of galvanized steel
- Aluminum-aluminum microchannel condenser battery
- 230Vac radial fans
- Automatic condensate evaporation (mod.250 excluded)
- Analogical (mod.ALX) or digital (mod.ALXC) temperature control
- Installation on external walls, backpack positioning

MODE OF OPERATION

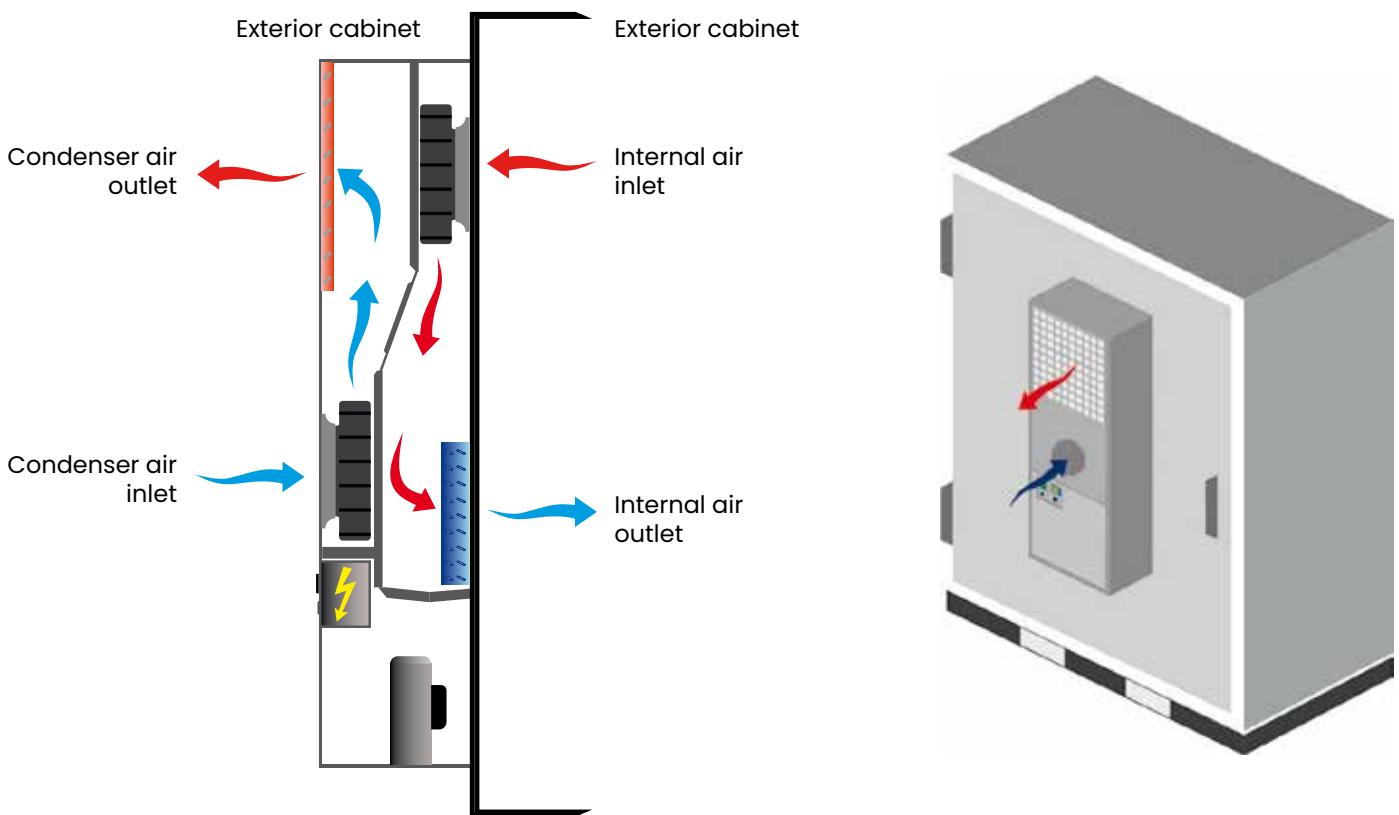

TECHNICAL DATA

Model		CU060ALX CU060ALXC	CU100ALX CU100ALXC	CU150ALX CU150ALXC	CU200ALX CU200ALXC	CU250ALX CU250ALXC					
Cooling capacity ⁽¹⁾	W	560	600	1090	1145	1510	1590	1950	2050	2400	2500
Power absorption	W	270	315	475	540	775	870	810	885	1040	1140
Voltage supply	V/pH/Hz	230/1		230/1		230/1		230/1		230/1	
Frequency	Hz	50	60	50	60	50	60	50	60	50	60

(1) External Temperature 35°C - Inside Temperature 35°C - R.H. =20%



Free cooling system

Free cooling is the ideal solution to guarantee continuous air exchange and efficiently transfer the heat generated by the equipment to the outside, contributing to energy savings even in installations with pre-existing air conditioners without free cooling. Thanks to PLC control, the use of low-noise EC fans and the possibility of ductable or still-chamber configurations, our Free cooling systems offer high performance and versatility for both indoor and outdoor installations.



Data centre



Motorway



Railway



Telecom

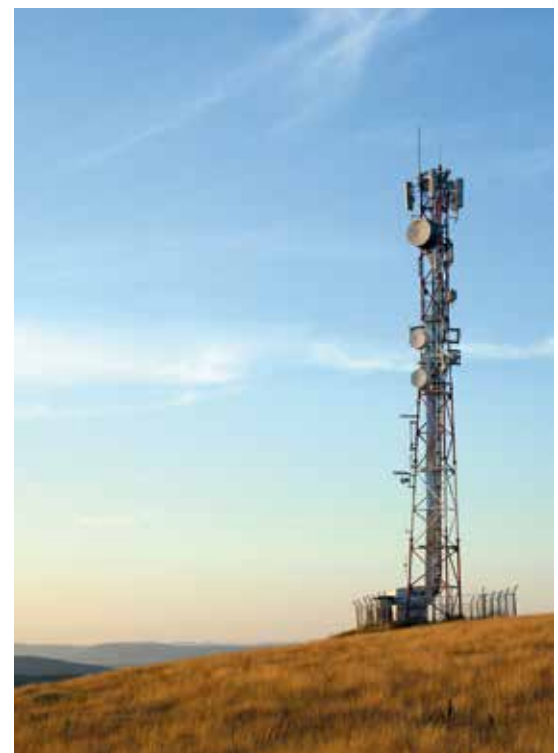

**Free cooling system
ensures continuous air
changes to efficiently
dissipate heat and
optimise energy savings**



FREE COOLING SYSTEMS

Extraction air system with grids FC-GR Series

Indoor installation
Air flow rate from 1000 m³/h to 4000 m³/h

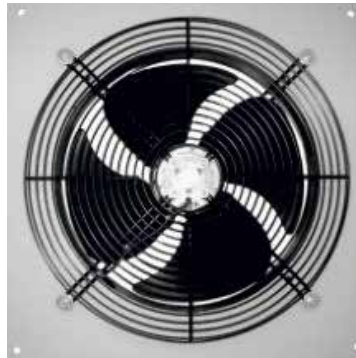

The Free-cooling system has the characteristic of guaranteeing continuous air changes with the primary objective of transferring the heat generated by the equipment to the external environment (for dissipation). Solution designed to allow high ENERGY SAVING also in site where air conditioning units without free cooling system were previously installed.

MAIN FEATURES

- PLC control
- EC axial fan, 48Vdc (230Vac on request)
- Low noise levels

MODE OF OPERATION

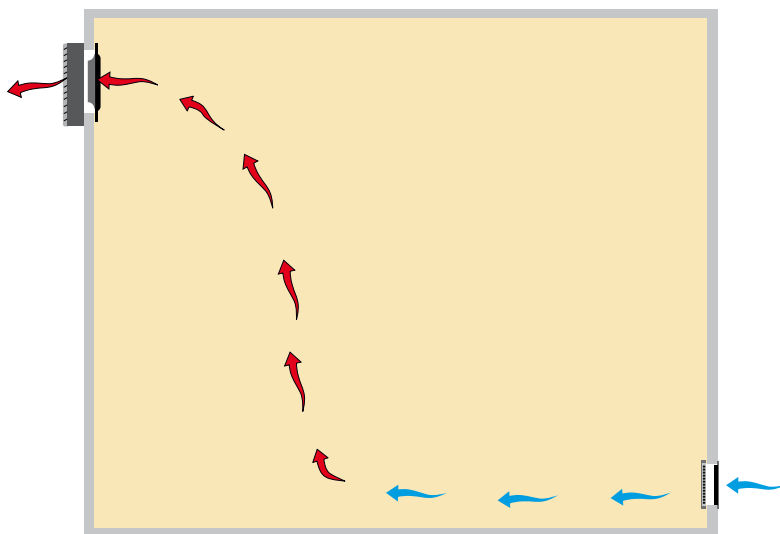

FREE COOLING SYSTEMS

Free cooling systems with canalised grilles

VFC Series

Indoor installation

Air flow rate from 1000 m³/h to 4000 m³/h



The Free-cooling system has the characteristic of guaranteeing continuous air changes with the primary objective of transferring the heat generated by the equipment to the external environment (for dissipation). Solution designed to allow high ENERGY SAVING also in site where air conditioning units without free cooling system were previously installed.

MAIN FEATURES

- PLC control
- Centrifugal fan EC, 48Vdc (230Vac on request)
- Low noise levels
- Ducting possibility

MODE OF OPERATION

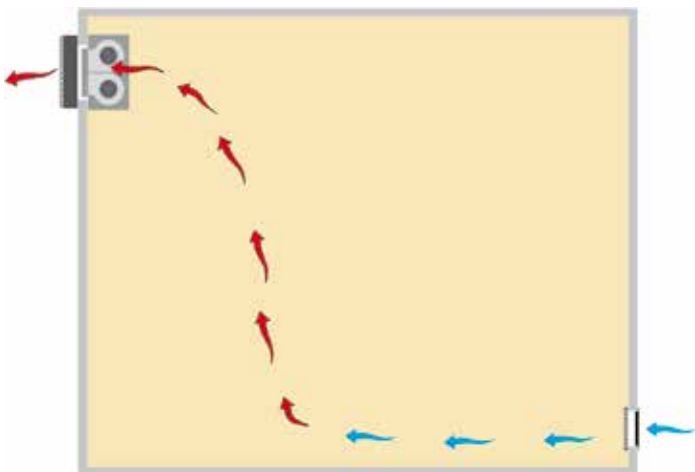

CANALIZED INSTALLATION (ON REQUEST)

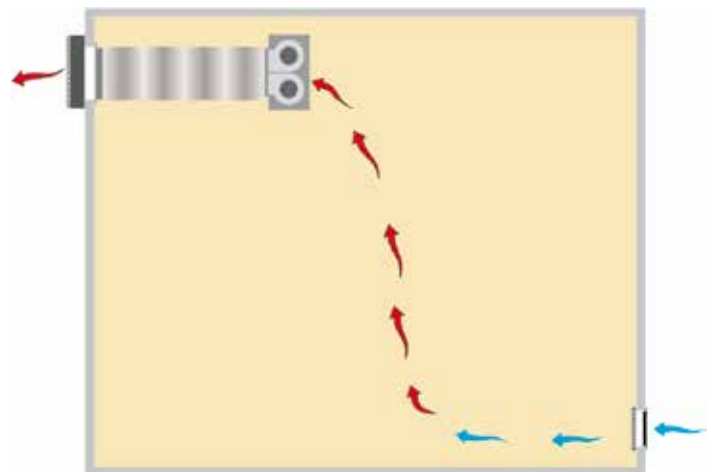

FREE COOLING SYSTEMS

Free cooling systems with canalised grilles FCCB Series

Indoor installation
Air flow rate from 2500 m³/h to 7000 m³/h



The Free-cooling system has the characteristic of guaranteeing continuous air changes with the primary objective of transferring the heat generated by the equipment to the external environment (for dissipation). Solution designed to allow high ENERGY SAVING also in site where air conditioning units without free cooling system were previously installed.

MAIN FEATURES

- PLC control
- Centrifugal fan EC, 48Vdc (230Vac on request)
- Low noise levels
- Ducting possibility

MODE OF OPERATION

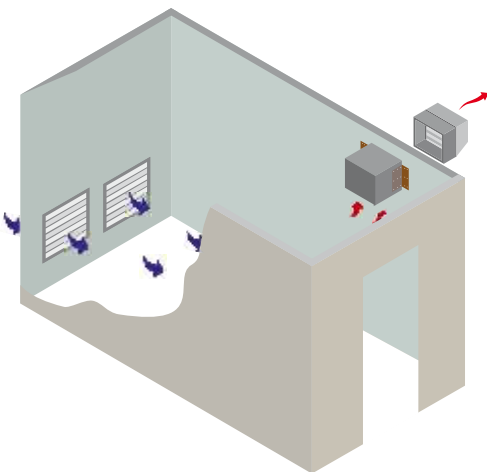

CANALIZED INSTALLATION (ON REQUEST)

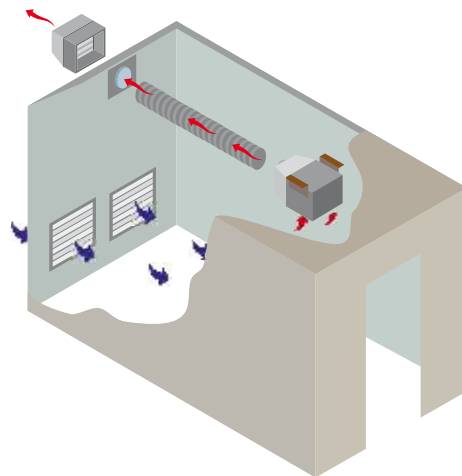

FREE COOLING SYSTEMS

Free cooling systems with canalised grilles FCCBE Series

Indoor installation
Air flow rate from 2500 m³/h to 7000 m³/h



The Free-cooling system has the characteristic of guaranteeing continuous air changes with the primary objective of transferring the heat generated by the equipment to the external environment (for dissipation). Solution designed to allow high ENERGY SAVING also in site where air conditioning units without free cooling system were previously installed.

MAIN FEATURES

- PLC control
- Centrifugal fan EC, 48Vdc (230Vac on request)
- Low noise levels
- Ducting possibility

MODE OF OPERATION

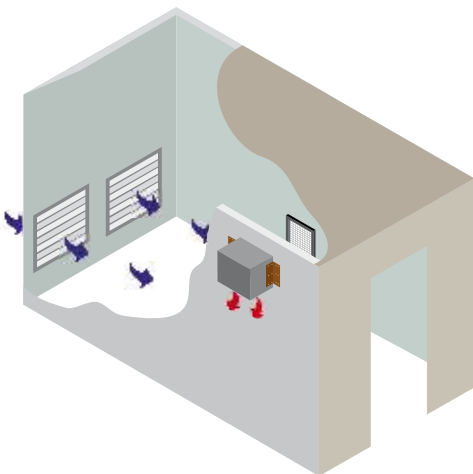

CANALIZED INSTALLATION (ON REQUEST)

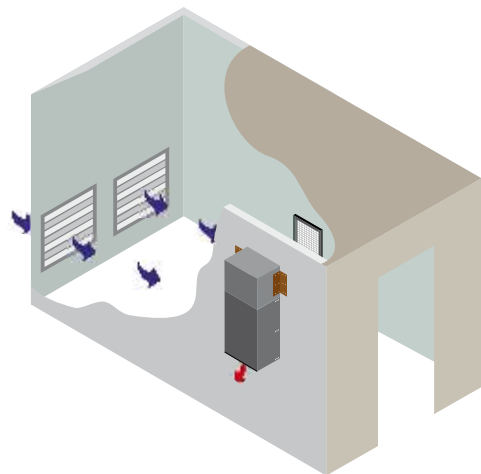

FREE COOLING SYSTEMS

Internal Settling Camber free-cooling CAM-I-ES Series

Indoor installation
Air flow rate from 2000 m³/h to 4000 m³/h

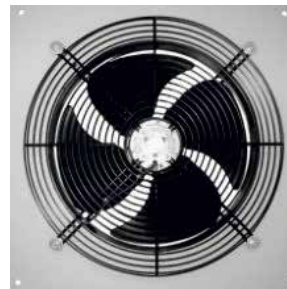

The Free-cooling system has the characteristic of guaranteeing continuous air changes with the primary objective of transferring the heat generated by the equipment to the external environment (for dissipation). Solution designed to allow high ENERGY SAVING also in site where air conditioning units without free cooling system were previously installed.

MAIN FEATURES

- PLC control
- External painted sheet metal panels
- Wide filtering surface area
- Centrifugal fan EC, 48Vdc (230Vac on request)
- Low noise levels

MODE OF OPERATION

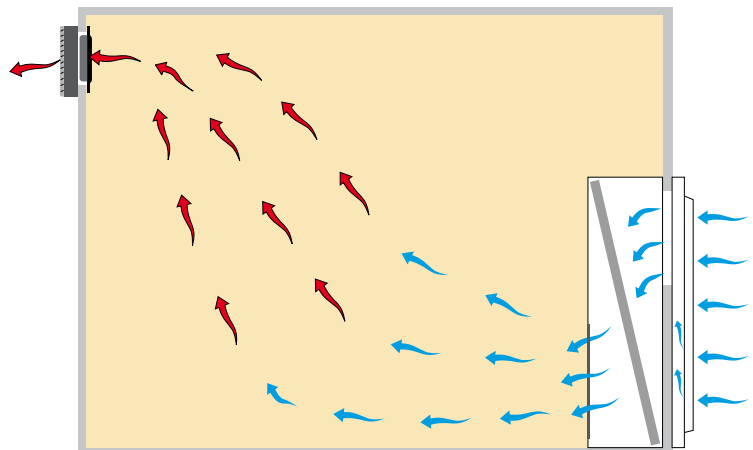

FREE COOLING SYSTEMS

External Settling Camber free-cooling CAM-E-ES Series

Outdoor installation
Air flow rate from 2000 m³/h to 4000 m³/h

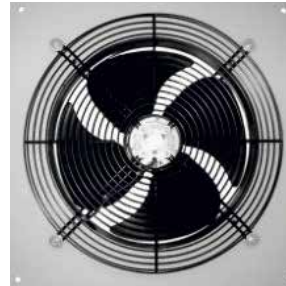

The Free-cooling system has the characteristic of guaranteeing continuous air changes with the primary objective of transferring the heat generated by the equipment to the external environment (for dissipation). Solution designed to allow high ENERGY SAVING also in site where air conditioning units without free cooling system were previously installed.

MAIN FEATURES

- PLC control
- External painted sheet metal panels
- Wide filtering surface area
- Centrifugal fan EC, 48Vdc (230Vac on request)
- Low noise levels

MODE OF OPERATION

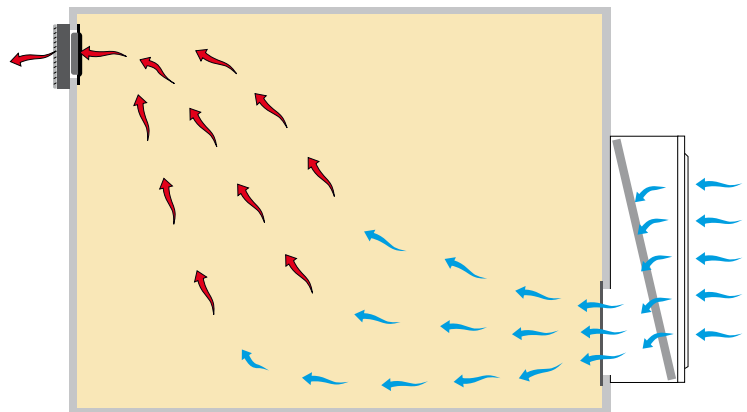

FREE COOLING SYSTEMS

Internal Free-cooling kit PASCI Series

Indoor installation
Air flow rate from 1500 m³/h to 3000 m³/h



The Free-cooling system has the characteristic of guaranteeing continuous air changes with the primary objective of transferring the heat generated by the equipment to the external environment (for dissipation). Solution designed to allow high ENERGY SAVING also in site where air conditioning units without free cooling system were previously installed.

MAIN FEATURES

- PLC control
- External painted sheet metal panels
- Centrifugal fan EC, 48Vdc (230Vac on request)
- Low noise levels

MODE OF OPERATION

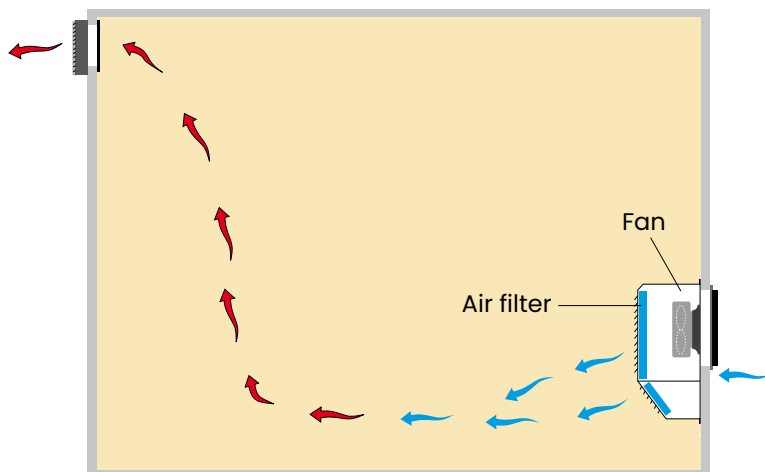

FREE COOLING SYSTEMS

External Free-cooling kit PASCE Series

Outdoor installation
Air flow rate from 1500 m³/h to 3000 m³/h



The Free-cooling system has the characteristic of guaranteeing continuous air changes with the primary objective of transferring the heat generated by the equipment to the external environment (for dissipation). Solution designed to allow high ENERGY SAVING also in site where air conditioning units without free cooling system were previously installed.

MAIN FEATURES

- PLC control
- External painted sheet metal panels
- Centrifugal fan EC, 48Vdc (230Vac on request)
- Low noise levels

MODE OF OPERATION

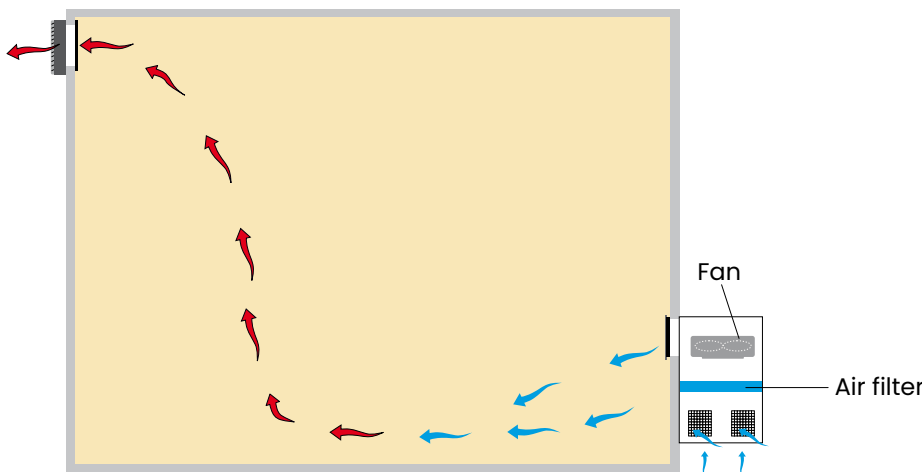

FREE COOLING SYSTEMS

Internal Settling Camber free-cooling CAM-I-IM Series

Indoor installation
Air flow rate from 2600 m³/h to 5000 m³/h



The Free-cooling system has the characteristic of guaranteeing continuous air changes with the primary objective of transferring the heat generated by the equipment to the external environment (for dissipation). Solution designed to allow high ENERGY SAVING also in site where air conditioning units without free cooling system were previously installed.

MAIN FEATURES

- PLC control
- External painted sheet metal panels
- Wide filtering surface area
- Centrifugal fan EC, 48Vdc (230Vac on request)
- Low noise levels

MODE OF OPERATION

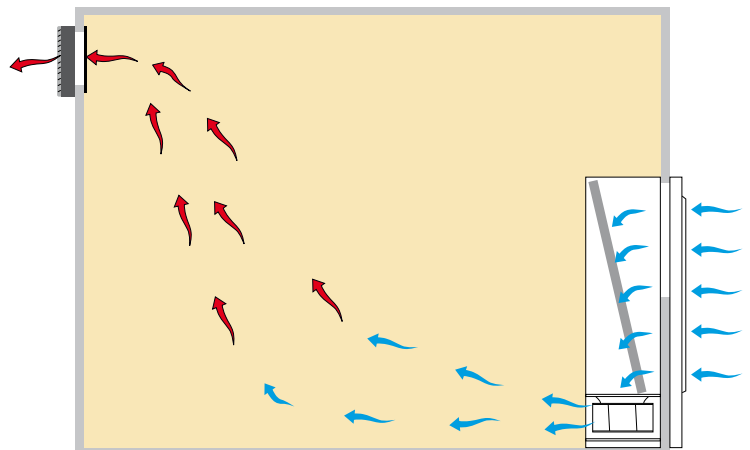

FREE COOLING SYSTEMS

External Settling Camber free-cooling CAM-E-IM Series

Outdoor installation
Air flow rate from 2600 m³/h to 5000 m³/h



The Free-cooling system has the characteristic of guaranteeing continuous air changes with the primary objective of transferring the heat generated by the equipment to the external environment (for dissipation). Solution designed to allow high ENERGY SAVING also in site where air conditioning units without free cooling system were previously installed.

MAIN FEATURES

- PLC control
- External painted sheet metal panels
- Wide filtering surface area
- Centrifugal fan EC, 48Vdc (230Vac on request)
- Low noise levels

MODE OF OPERATION

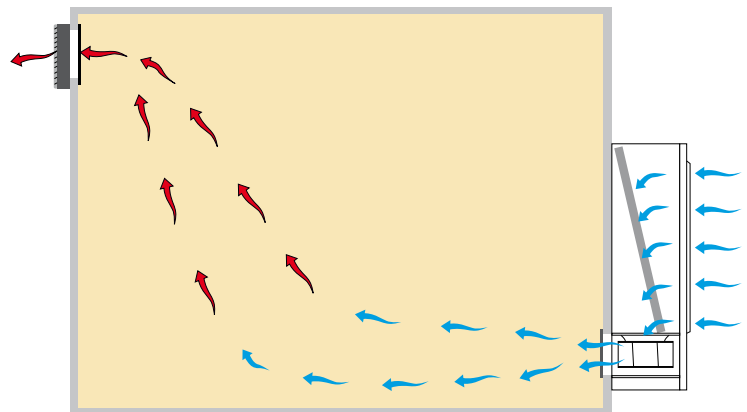

Ethratech – Products Catalogue | Rev.1 Version April 2025 | ENG

Copyright © Enex Technologies

All rights reserved in all Countries.

The technical data and information expressed in this publication are owned by Enex Technologies and have general information. With a view to continuous improvement, Enex Technologies has the right to make at any time, without any obligation or commitment, all the modifications deemed necessary for the improvement of the product, for this reason even substantial changes can be made to the documentation without notice. The example images of the products and components inside the units are illustrative and therefore any brands of the components functional to the construction of the units may differ from any brands represented in this document. This catalog has been prepared with the utmost care and attention to the contents displayed, nevertheless Enex Technologies cannot assume any responsibility deriving from the use, direct or indirect, of the information contained therein.



 **enex technologies**
cooling and heating naturally

www.enextechnologies.com • info@enextechnologies.com

REV.25-01

enex
INNOVATION AS ENERGY

kobcl Refrigeration
INNOVATION AS ENERGY

enex Industrial
INNOVATION AS ENERGY

EMICON
INNOVATION AS ENERGY

ETHRATECH
INNOVATION AS ENERGY

kobcl
HEAT EXCHANGERS NATURALLY

MORGANA
HEAT EXCHANGERS NATURALLY

ROENEST
HEAT EXCHANGERS NATURALLY